

3G HUMAN ANCESTOR?... (A new theory on Human Cell Mass growth and Gene growth)

M.Arulmani, V.R.Hema Latha

¹B.E. (Engineer) ²M.A., M.Sc., M.Phil. (Biologist)

Abstract: - In Biological science concept, DNA is normally considered packed in the form of one or more macro molecules called “chromosome” which carriers genetic information in the “cell” through “GENES”.

A scientific research analysis in this article focus that “3G HUMAN” shall be considered as the first life organism evolved in the universe. “3G” shall mean “THREE GENE” derived from three fundamental Neutrinos of the Universe. In the Expanding Universe, the fundamental Neutrinos might have gained mass and produced thousands of Species Neutrinos in the three generation of geological periods. It is speculated that thousands species Neutrinos might have added additional genes to the three fundamental gene. In brief it is focused that three generations of higher mass Neutrinos might have generated three generations of “genetically varied human”. This research further focus that the 3G HUMAN shall be considered as 1st generation human and probably lived in “MARS PLANET” with different genetic structure. The so called Modern Human shall be considered as 3rd generation human and 2nd generation human might have lived in between. The genetic study confirms that the Bacteria has 500 genes and Modern human have around 20,000 to 30,000 genes. This research concludes that in the evolutionary progression from bacteria to Invertebrates, vertebrates, Modern human all the subsequent derived genes might have derived from the fundamental three gene of 3G HUMAN ANCESTOR. The fundamental Neutrinos shall be considered as “GOD PARTICLES”. Hence the 3G HUMAN ANCESTOR shall be considered as “GOD”.

Key Words: -

- | | |
|--|---|
| 1) Philosophy of God Particles | 4) Philosophy of Human Blood evolution |
| 2) Philosophy of “ Tablet ” | 5) Philosophy of PH Variation |
| 3) Philosophy of eye Iris Variation | 6) Philosophy of Universe. |

I. INTRODUCTION

This article emphasis that the **3G HUMAN ANCESTOR** on origin had only 3Gene having least cell mass least PH value Dark eye Iris. It is further focused that every human on birth has **different cell mass** and the cell mass of one individual **can't exactly** march with other **theoretically** even within the same family members. In other words it can be stated that every individual has his own “**Cell Mass Index**”. This “**Cell Mass Index**” of the person can be considered equivalent to independent “**SIM CARD**” of Mobile Phone distinguished by “**specific number**”.

The three generation human shall be considered as distinguished by wide difference in the “**Bandwidth of Cell mass**” which might have necessitated for wide difference in the “**Bandwidth of genetic characteristics**”

It is speculated that different **disease, disorders** shall be considered as **Harmonics** which alters the normal “**cell mass index**” of a person. Consuming medicine for various disease shall be considered as means restoring the cell mass index to the **normal level**.

“Different medicine is required for different person of different, cell mass index for the same disease”

- Author

II. PREVIOUS PUBLICATIONS

The philosophy of origin of first life and human, the philosophy of model Cosmo Universe, the philosophy of fundamental neutrino particles have already been published in various international journals mentioned below. Hence this article shall be considered as **extended version** of the previous articles already published by the same author.

- [1] Cosmo Super Star – IJSRP, April issue, 2013
- [2] Super Scientist of Climate control – IJSER, May issue, 2013
- [3] AKKIE MARS CODE – IJSER, June issue, 2013
- [4] KARITHIRI (Dark flame) The Centromere of Cosmo Universe – IJIRD, May issue, 2013
- [5] MA-AYYAN of MARS – IJIRD, June issue, 2013
- [6] MARS TRIBE – IJSER, June issue, 2013
- [7] MARS MATHEMATICS – IJERD, June issue, 2013
- [8] MARS (EZHEM) The mother of All Planets – IJSER, June issue, 2013
- [9] The Mystery of Crop Circle – IJOART, May issue, 2013
- [10] Origin of First Language – IJIRD, June issue, 2013
- [11] MARS TRISOMY HUMAN – IJOART, June issue, 2013
- [12] MARS ANGEL – IJSTR, June issue, 2013
- [13] Three principles of Akkie Management (AJIBM, August issue, 2013)
- [14] Prehistoric Triphthong Alphabet (IJIRD, July issue, 2013)
- [15] Prehistoric Akkie Music (IJST, July issue, 2013)
- [16] Barack Obama is Tamil Based Indian? (IJSER, August issue, 2013)
- [17] Philosophy of MARS Radiation (IJSER, August 2013)
- [18] Etymology of word “J” (IJSER, September 2013)
- [19] NOAH is Dravidian? (IJOART, August 2013)
- [20] Philosophy of Dark Cell (Soul)? (IJSER, September 2013)
- [21] Darwin Sir is Wrong?! (IJSER, October issue, 2013)
- [22] Prehistoric Pyramids are RF Antenna?!... (IJSER, October issue, 2013)
- [23] HUMAN IS A ROAM FREE CELL PHONE?!... (IJIRD, September issue, 2013)
- [24] NEUTRINOS EXIST IN EARTH ATMOSPHERE?!... (IJERD, October issue, 2013)
- [25] EARLY UNIVERSE WAS HIGHLY FROZEN?!... (IJOART, October issue, 2013)
- [26] UNIVERSE IS LIKE SPACE SHIP?!... (AJER, October issue, 2013)
- [27] ANCIENT EGYPT IS DRAVIDA NAD?!... (IJSER, November issue, 2013)
- [28] ROSETTA STONE IS PREHISTORIC “THAMEE STONE” ?!... (IJSER, November issue, 2013)

III. HYPOTHESIS

1) The 3G Human Ancestor is considered derived “**three gene**” from three fundamental neutrinos of the universe. The three neutrinos shall be distinguished by the alphabet **A, K, J** to differentiate the physical, chemical, mathematical characteristics.

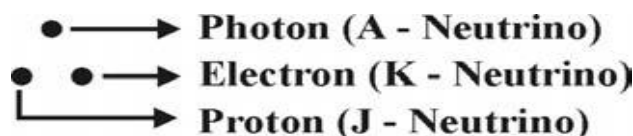

2) Increase **cell mass Index** shall be considered as increasing the gene in **microbial level**. Wide difference in cell mass Index shall be considered increasing wide **genetic characteristics**.

3) Wide cell mass Index variation shall have impact on **cell structure, cell size** and shall contribute to wide variation in **PH value, eye Iris, evolution of New blood group**.

IV. HYPOTHETICAL NARRATION

1. Philosophy of 3G Human Origin?...

In the expanding Universe 3G human shall be considered as “**first organism**” **spontaneously** evolved from star dust particles. The 3G Human shall be considered as evolved from most fundamental neutrinos, i.e. **Photon Neutrino, Electron Neutrino, Proton Neutrino**. The three fundamental neutrinos shall be considered as responsible for existence of all matters in the **universe**. The 3G Human shall be defined within the following scope.

- 1) **3G human** had only 3 Chromosome, 3 Gene derived from three fundamental Neutrinos.
- 2) **3G Human** had 3G Blood “**AB**” Type on origin.
- 3) **3G human** had “**least cell mass**”.

- 4) **3G human** had least “PH Value of Blood”.
- 5) **3G human** had “Dark Blue Iris”.
- 6) **3G human** was capable of “flying”.

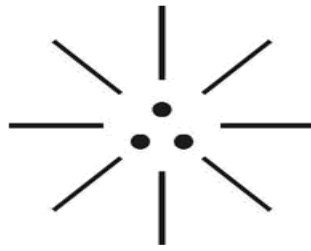

(Fundamental Neutrinos)

- (a) Right dot (Proton) - Considered as **DNA** of the cell
- (b) Left dot (Electron) – Considered as **HORMONE** of the cell
- (c) Center dot (Photon) – Considered as **RNA** of the cell

2. Neutrinos are God Particles?...

It is focused that the fundamental Neutrinos considered as evolved from **star dust** of universe shall be considered as God particles. Thousand of subsequent Neutrinos evolved in three generation of geological periods shall be considered as “**species**” to God particles.

(i)



(Star Dust)

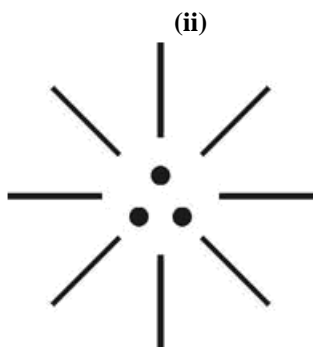

(3G Genome)

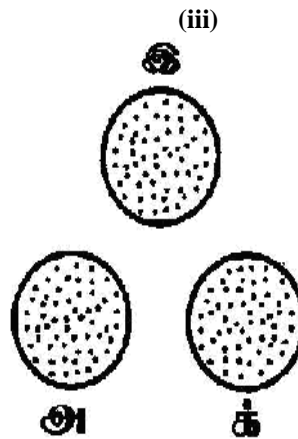

(Gene growth with higher cell mass)

(iv)

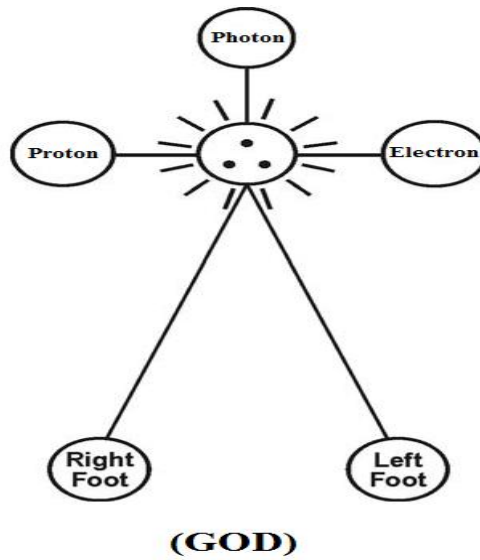

3. Neutrinos are genetic Tablets?...

It is focused that Tablets shall be considered as **prehistoric scientific logic** comprising of three tablets meant for **translating** the genetic information of the 3G Human Ancestor.

It is focused that the 3G Human lived in MARS PLANET shall be considered as **Super scientist** and expert in **Astrophysics, Astronomy, Genetics** might have formulated the scientific logic in “Three Tablets”.

(i)

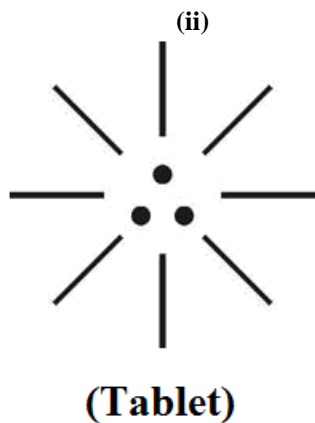
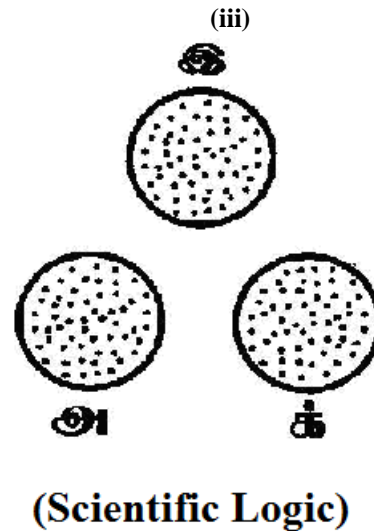
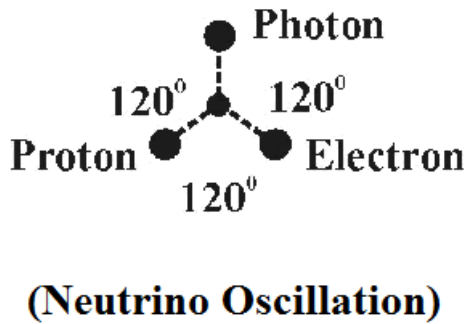

4. Neutrinos are having genetic structure?...

It is focused that the three-in-one fundamental neutrinos of the universe shall be considered having defined structure and have sustained oscillation. It is speculated that the philosophy of cell region **DNA**, **HARMONE**, **RNA** Molecular structure might have been derived from the philosophy of fundamental Neutrinos.

(i)

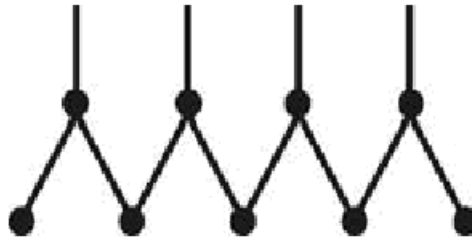

(Neutrino Based Molecular Structure)

(ii)

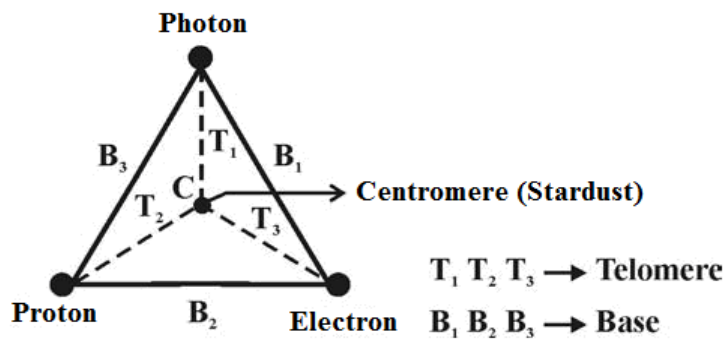

(Neutrino Based Gene)

(iii)

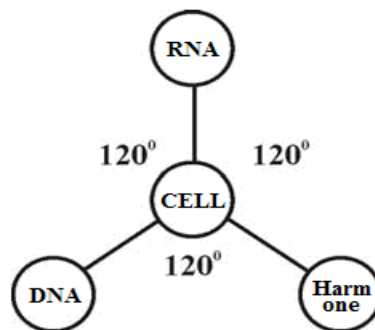

(Neutrino Based Cell)

5. Neutrinos have genetic characteristics?...

It is focused that bottom two dot shall be considered having directly opposite in characteristics.

- a) Right dot (proton) – Responsible for **functional** characteristics
- b) Left dot (Electron) – Responsible for **structural** properly
- c) Centre dot (Photon) – Law for **regulation** of gene process

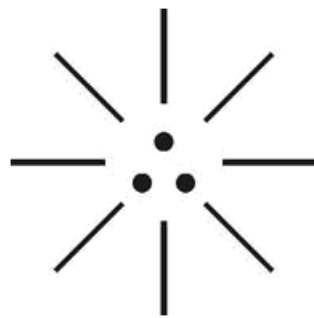
**(3G Fundamental)****6. Neutrinos have gender characteristics?...**

It is focused that the three dot shall be considered indicating three type of gender.

- a) Right dot – **male gender**
- b) Left dot – **Female gender**
- c) Centre dot – **Dual gender**

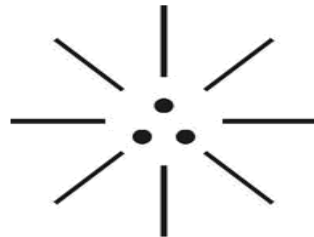
**(3G Gender)**

It is further focused that the **3G HUMAN** have only three chromosome. The bottom two dot shall be considered as “**Autosome**” and centre dot shall be considered as Dual Gender (Half male, Half Female)

7. Philosophy of colour of Eye Iris?...

It is focused that the variation in colour of “**Human eye iris**” shall be considered due to progressive **increase in Gene** in the cell and considerable increase in **cell mass**. The increase in gene growth shall be considered as increase in **DNA Mass, RNA Mass, Hormone Mass**. The Billions of **human iris colour** shall be classified under three most fundamental colour **Bandwidth** during the course of expanding universe.

- 1) “**Dark Blue**” .. **Lower Cell Mass** (Prehistoric Human)
- 2) “**Dark Green**”.. **Moderate Cell Mass** (Ancient Human)
- 3) “**Dark Red**” .. **Higher Cell Mass** (Modern time Human)

This research focus that the global level in different region human having “**three type of eye iris bandwidth**” shall be considered as “**three generations**” of human in different period during the course of expanding universe. The **Dark Blue Iris**” shall also be called as Prehistoric “**J**” – **Iris**.

(i)

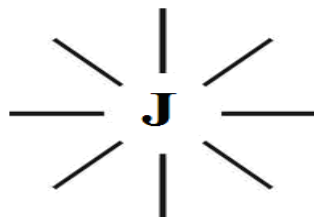
**(3G Eye)**

(ii)



(Prehistoric dark blue eye iris)

8. Philosophy of Human Blood Variation?...

It is focused that human blood shall be considered as natural product of fundamental neutrinos. It is speculated that AB type blood shall be considered as 3G Blood on origin. All other blood types A, B, O shall be considered as species blood to AB blood and which might be evolved in three generation of geological period due to subsequent growth of human cell mass index and additional genes.

9. Philosophy of PH Variation?...

It is focused that in prehistoric time the PH value of blood might be well below 7.0 and might be show acidic. In expanding Universe the PH value of blood might become variant in three generations due to growth of cell mass index and additional genes.

10. Philosophy of Human Blood PH Variation?...

It is focused that AB blood type shall be considered as “3G blood” having least cell mass, least PH Value on origin. The AB Blood shall also be considered as “BLACK BLOOD” or **Black Body Blood**. The following different type of human blood shall be considered as evolved from **AB type** during the course of Expanding Universe in **different environment**.

- 1) **AB type** - **Least PH Value and least cell mass** (Prehistoric time)
- 2) **A, B type** - **Moderate PH Value and Moderate cell mass** (Ancient time)
- 3) **O type** - **Higher PH value and Higher cell mass** (Modern time)

It is focused that AB Type blood shall be considered as 1st generation blood; **AB, A, B** shall be considered as 2nd generation blood; **AB, A, B, O** shall be considered as 3rd generation type.

11. Philosophy of GOD?...

The philosophy “**God**” shall be distinguished from “**human**” within the following scope.

- 1) **God** shall be considered as having **3Gene with Zero Cell mass**.
- 2) **God** shall be considered as having **Blood of Zero PH Value**.
- 3) **God** shall be considered as having absolutely “**Dark eye Iris**”.

12. How 3G Human looks like?...

This research focus that the 3 G human shall be considered having different genetic characteristics and capable of flying due to impact of low level Telomere sequence.. Further the 3G human on origin shall be considered having highly **Acidic Blood** and lived in **MARS Planet** in Prehistoric time having high immunity. From **Biblical understanding** the 3G human shall be considered as “**ANGEL**”, “**ADAM**”.

Bible source:
 Bible evidence shows that prehistoric human populations are
 capable of flying in the sky
 (Ps 91:4, Ps 36:7, Ruth 2:12, Luk 2:10-13, Mal 4:1-5).

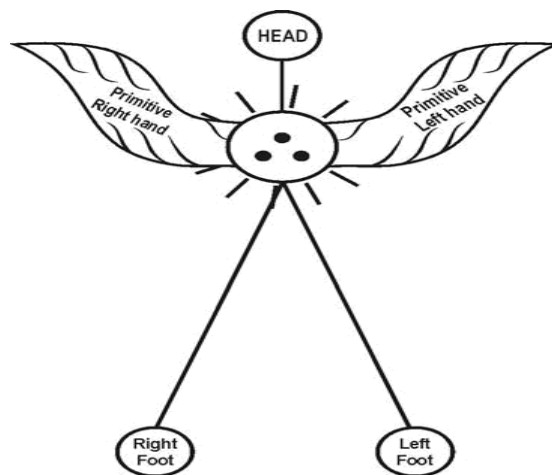

(3G HUMAN ANCESTOR)

13. What Universe Means?...

It is focused that the Universe shall be considered influenced by fundamental neutrinos and electromagnetic radiation under which all matters weather organic or inorganic shall be considered as existing under **equilibrium condition**. Further all matters shall be considered undergoing changes in characteristics in three generation due to expanding Universe. As such bacteria, amoeba, plants, vertebrates, apes, human etc shall be considered as under distinguished head of three generation variant genetic structure.

It is focused that apes shall be considered as second generation matter after long evolutionary gap of **3G HUMAN ANCESTOR**. It is further focused that not only apes even bacteria with 500 genes might have been evolved after evolution of 3G human when the neutrinos gained additional mass in the expanding Universe which might have contributed 500 genes to the bacteria.

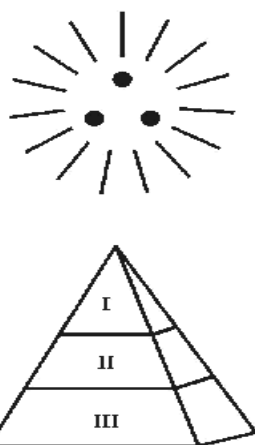

(Model 3 Generation matter growth)

V. CASE STUDY

1) Case study of Impact of growth of cell mass?

In any given steady state culture of Escherichia coil cells, initiation of DNA replication at the chromosomal origin occurs at a specific time in the cell cycle at "specific cell mass"

The distribution of cell mass was determined for each DNA content (ie. each fluorescence) in each histogram.

The initiation of mass (mi) is determined as the average mass where one-chromosome cell starts to increase their DNA content.

The different aspect of the DNA replication, cell division relationship is displayed by newborn dnaA mutant cells: they have a much higher mass than dividing wild-type cells and yet they are not ready to divide.

(Contributed by Nancy Kleckner July 25, 1996)

“Coordinating DNA replication initiation with cell growth: Differential roles for DnaA and SeqA proteins”

Harwad University, Cambridge MA02138.

2) **Case study on modern human gene:**

At a relatively recent time as Evolution goes, modern humans acquired an extra 223 genes not through gradual evolution, not vertically on the tree of Life, but horizontally, as a sideways insertion of genetic material from Bacteria...

(Genome Discovery by Zecharia Sitchin Spanish version from Zecharia sitchin Web site)

3) **Case study on Y chromosome:**

A single female ancestor who lived about 1,40,000 years ago, but that genes on the Y chromosome trace back to the male who lived about 60,000 to 90,000 years ago. Further the bulk of genes in the nucleus all trace back to different time about two million years.

..... Google search

VI. CONCLUSION

It is focused that the so called “ANGEL” population shall be considered as having only single type **AB** Blood with **little lower cell mass** compared to **ADAM, EVE**. ADAM, EVE, shall be considered having higher cell mass and “species” to “Angel Populations”. The Angel shall be defined within the following scope.

- 1) **Angel** shall be considered as species to “**3G Human**”.
- 2) **Angel** shall be considered having “**Dark Blue Iris**”
- 3) **Angel** shall be considered having **Acidic Blood** having “**PH**” value much below **7.0**.

REFERENCE

- [1] Intensive Internet “e-book” study through, Google search and wikipedia
- [2] M.Arulmani, “3G Akkanna Man”, Annai Publications, Cholapuram, 2011
- [3] M. Arulmani; V.R. Hemalatha, “Tamil the Law of Universe”, Annai Publications, Cholapuram, 2012
- [4] Harold Koontz, Heinz Weihriah, “Essentials of management”, Tata McGraw-Hill publications, 2005
- [5] M. Arulmani; V.R. Hemalatha, “First Music and First Music Alphabet”, Annai Publications, Cholapuram, 2012
- [6] King James Version, “Holy Bible”
- [7] S.A. Perumal, “Human Evolution History”
- [8] “English Dictionary”, Oxford Publications
- [9] Sho. Devaneyapavanar, “Tamil first mother language”, Chennai, 2009
- [10] Tamilannal, “Tholkoppiar”, Chennai, 2007
- [11] “Tamil to English Dictionary”, Suravin Publication, 2009
- [12] “Text Material for E5 to E6 upgradaton”, BSNL Publication, 2012
- [13] A. Nakkiran, “Dravidian mother”, Chennai, 2007
- [14] Dr. M. Karunanidhi, “Thirukkural Translation”, 2010
- [15] “Manorama Tell me why periodicals”, M.M. Publication Ltd., Kottayam, 2009
- [16] V.R. Hemalatha, “A Global level peace tourism to Veilankanni”, Annai Publications, Cholapuram, 2007
- [17] Prof. Ganapathi Pillai, “Sri Lankan Tamil History”, 2004
- [18] Dr. K.K. Pillai, “South Indian History”, 2006
- [19] M. Varadharajan, “Language History”, Chennai, 2009
- [20] Fr. Y.S. Yagoo, “Western Sun”, 2008
- [21] Gopal Chettiar, “Adi Dravidian Origin History”, 2004
- [22] M. Arulmani; V.R. Hemalatha, “Ezhem Nadu My Dream” - (2 Parts), Annai Publications, Cholapuram, 2010
- [23] M. Arulmani; V.R. Hemalatha, “The Super Scientist of Climate Control”, Annai Publications, Cholapuram, 2013, pp 1-3