

THE PHILOSOPHY OF “DALIT”?...(A new theory on “JATIS”)

M.Arulmani, V.R.Hema Latha,

¹B.E. (Engineer) ²M.A., M.Sc., M.Phil. (Biologist)

Abstract: - It is focused that in human social system “Dalits” are considered as an “out-caste” and treated them as “Untouchables” and being ill-treated almost in every day of Life. **If so, where did Dalits come from?...**

Since Ancient time global level Scientists, Scholars, Anthropologists could not exactly answer who are Dalits?... Further world wide Untouchability, Casteism discrimination being practiced besides “BLACK” and “WHITE”, ethnics. Further hundreds of castes, sub castes exist within main “Ethnic frame” of religions like Hinduism, Christianity, Islam, Buddhism, considering Dalits as distinguished out-caste.

It is focused that in developing countries like “INDIA” the sense of “Casteism” is more dominant in rural area and the Parents of the Nations, though highly educated, do not know how to grow their children to eradicate the sense of Casteism without understanding the **reality of nature**.

- | | |
|---|--|
| (i) Indians are killing Indians on Casteism. | (v) Europeans are killing Europeans on Casteism. |
| (ii) Srilankans are killing Srilankans on Casteism. | (vi) Americans are killing Americans on Casteism. |
| (iii) Africans are killing Africans on Casteism. | (vii) Australians are killing Australians on Casteism. |
| (iv) Afghanistans are killing Afghanistans on Casteism. | |

This research further focus that the Philosophy of “DALITS” shall be understood and represented in “BIOLOGICAL LANGUAGE” as mentioned below. In biological term the “DALIT STAGE” shall be considered as invisible existence associated with dirty water and other minerals converted as food for subsistence of life.

It is further focused that the Philosophy of “JATIS” might be derived from the Philosophy of **stages of tree**.

- | | |
|---------------------------|---------------------------|
| (i) Fruit – Brahmin | (iv) Upper stem – Shudras |
| (ii) Leaves – Kshatriyas | (v) Tender stem – Dalits |
| (iii) Branches – Vaishyas | (vi) Roots – Endo Gene |

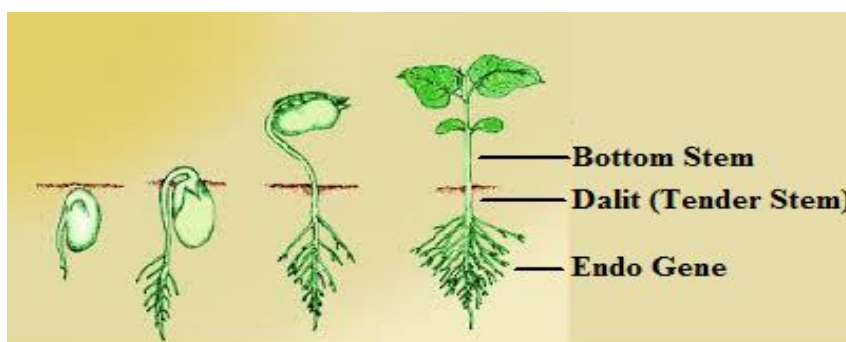
**(Philosophy of DALIT Evolution)**

The “DALITS” are like Image of “ALIENS” and considered like “PLASMA HUMAN” and fundamental Building Block of all generations of Human races on the “EARTH PLANET”. “Dalits are like **tender stem of Tree** and thousands of branches shall be considered as generations of races. Dalits are like **stem cells (Umbilical Cell ions)** and thousands of varied cells shall be considered derived from stem cells”.

- Author

Key Words: -

- a) Philosophy of “ENDOS”
- b) Philosophy of “INDOS”
- c) Philosophy of “PLASMA HUMAN”
- d) Philosophy of “THAI-e”
- e) Philosophy of “THALI”
- f) Etymology of “DALIT”
- g) Etymology of “CASTE”
- h) Philosophy of “DALIT BLOOD GROUP”
- i) Philosophy of “DALIT EYE IRIS”

I. INTRODUCTION

It is focused that according to **Human rights watch, UNICEF**, caste discrimination affects an estimated **250 million** people world wide.

In human social system under “**Varna theory**”, “**JATIS**” are classified under four major Category **Brahmins, Kshatriyas, Vaishyas, shudras**. Subsequently Dalits term was invented separately as **PANCHAMAS** and considered as out-caste Untouchables just like “**Mother-in-law**” ill treating “**Daughter-in-law**”.

In 2008 the national Commission of India for SC/ST Seriously observed that the term “**Dalit**” should not be used interchangeably along with other classified classes under the schedule. In general Dalits are also called as **Harijans, Adivashi, Adi Dravidas, Adi Andhras, Adi Karnatakas, Adi Dharmis**.

It is focused that **Ancient Hindu Texts** suggest caste system was not rigid. The Flexibility permitted so called Lower caste “**VALMIKI**” to compose “**RAMAYANA**” which was widely adopted and become a major “**Hindu Practice**”.

This Scientific research focus that “**ETHIANS**” shall be considered as the **oldest populations** lived on the Earth Planet even before “**SUN EMITS FIRST RAYS**”. Ethians shall also be called as “**INDOS**” (or) “**BLACK POPULATION**”.

It is further focused that “**ETHIANS**” shall be considered as lived as a “**Single large family**” in Ancient time. During the course of “**Expanding Universe**” the Ethians shall be considered as diversified under “**Three major Ethnic groups**” and become “**THREE JATIS**” during geological evolution.

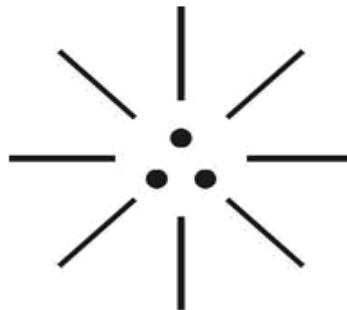

(ETHIAN LOGO)

- (i) **INDO – DRAVIDIAN**
- (ii) **INDO – EUROPEAN**
- (iii) **INDO – EGYPTIAN**

The Three Ethnic groups shall be distinctly identified with fundamental Ethnic Symbols (i.e) Indo-Dravidian as “**LION**”, Indo-European as “**LEOPARD**” Indo-Egyptian as “**ELEPHANT**”.

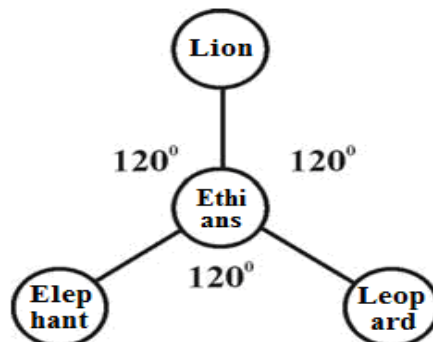

(Three Ethnic Jatis)

“Thousands of global level Ethnic symbols, Jatis, Castes, sub castes shall be considered derived from the three fundamental Jatis”

-Author

II. HYPOTHESIS AND NARRATION

a) Philosophy of “DALITS” origin?...

It is hypothesized that “INDOS” shall be considered as “IMAGE” of “ENDOS” who lived in “MARS PLANET” (also called as EZHEM). During the expanding Universe the ENDOS were considered Transformed as “PLASMA HUMAN” and descended to EARTH PLANET and become “INDOS”.

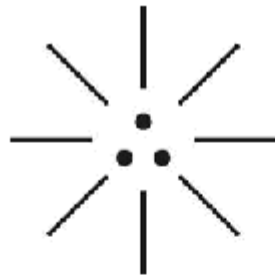

**ALIEN
(ENDOS)**

**Transformation &
Plasma barrier**

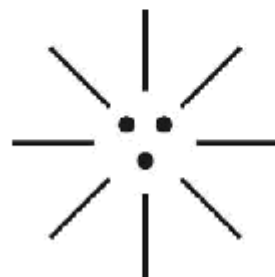

**DALITS
(INDOS)**

It is further focused that the “ENDOS” shall be considered as **genetically** well defined populations also called as “WHITE POPULATIONS” (ALIENS). The “INDOS” shall be considered as genetically Variant to ENDOS having “Highest genetic value” of all races of Earth planet. The “PLASMA HUMAN” shall be considered as the “Intermediate stage” between “ENDOS and INDOS”. The intermediate stage plasma human shall be called as “DALITS”.

The **philosophy of Dalits** (plasma human) shall be defined within the following scope.

- 1) Dalits shall mean “**genetically diffused**”
- 2) Dalits shall mean “**Image of ENDOS**”
- 3) Dalits shall mean “**Proto – INDOS**”
- 4) Dalits shall mean “**Utter Black**”
- 5) Dalits shall mean “**FIRST BORN ON EARTH**”
- 6) Dalits shall mean “**Thai-e**” (Thai-eth)
- 7) Dalits shall mean “**Stem cells of Human**”
- 8) Dalits shall mean “**TRIBE**”
- 9) Dalits shall mean “**Single Type Blood AB**”

10) Dalits shall mean “**DARK BLACK EYE IRIS**”

b) Philosophy of ENDOS?...

It is hypothesized that **ENDOS** shall be considered as evolved of “**J-RADIATION**” emanated from “**White Hole**” of Material Universe. The J-RADIATION shall be also called as “**Virgin light**” comprised of fundamental star particles **Photon, Electron, Proton** having **zero mass** and having **optic, electric, magnetic** characteristics. In prehistoric “**Proto-Indo language**” the virgin light shall be called as “**JYOTHI**”.

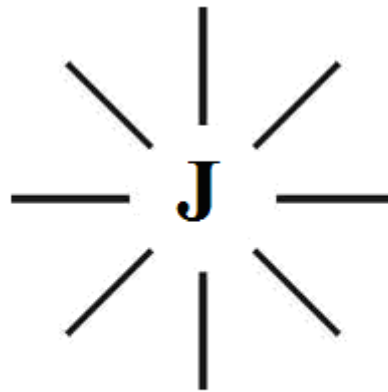

(JYOTHI)

The Etymology of Sanskrit word “JATI”, “JATA” shall be considered as derived from proto-Indo origin root word “**JYOTHI**”, “**CHATHI**”. CHATHI shall mean “**Heart**” (White hole), **JYOTHI** shall mean J-Radiation. Further in astronomical language the J-Radiation shall be considered as “**MATH**” (molecular cloud).

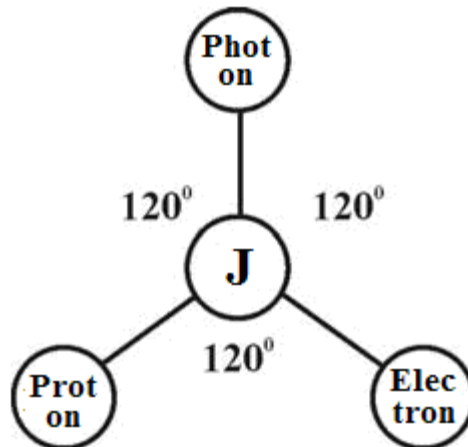

(CHATHI)

- i) Photon is like “**LION**” (**Indo-Dravidian**)
- ii) Electron is like “**LEOPARD**” (**Indo-European**)
- iii) Proton is like “**ELEPHANT**” (**Indo-Egyptian**)
- iv) “**J**” is like “**ETHIAN**”

c) Etymology of word “DALIT”?...

Case study shows that the word “**Dalit**” considered derived from Sanskrit origin meaning ground, suppressed, crushed (or) **broken to pieces**. The word was first used by “**Jyotirao Phule**” in 19th century.

Further the Sanskrit word **JATA** shall mean “**Born**” or brought into existence by birth.

It is hypothesized the **DALIT** might be derived from proto-Indo origin root word **Thai-e, Thalai,**

Ethu.

- i) **Thalai** shall mean **Head**.
- ii) **Ethu** shall mean **Birth**

- iii) **Thai-e** shall mean “**Mother of Dalit**”



THAI-e (MOTHER OF DALIT)

- d) **Etymology of word “Caste”?...**

It is hypothesized that the etymology of word “**Caste**” might be derived from Proto-Indo origin root “**Kalacharam**”, “**Kalai**”. Kalai, Kalacharam shall mean custom, culture, habit.

- e) **Philosophy of Word “Harijan”?...**

Caste study shows that “**Gandhiji**” used the word “**Harijan**” to denote the **suppressed class, untouchables**. Gandhiji coined term Harijan which means Children of God.

It is focused that the etymology of word Harijan might be derived from Proto-Indo origin root word “**KARISON**” (KARI + SON).

- i) “**KARI**” shall mean “**GOD**”
- ii) “**SON**” shall mean “**CHILD**”
- iii) “**KARISON**” shall mean “**Son of God**”.

- f) **Case study on Mangala Sudra?...**

It is focused that the philosophy of “**mangala Sudra**” shall be referred to uniting the Bridegroom, Bride in the custom of “**Marriage**”.

- i) “**Mangala**” shall mean “**Bride**”
- ii) “**Sudra**” shall mean “**Bride groom**”

Further the philosophy “**Thali**” refers to “**tying three knots**”. The philosophy of Thali might be derived from the Proto-Indo origin root word “**Thai-ethu**” (Dailit). “**Thai-ethu**” shall mean custom derived from “**Dalits**”.

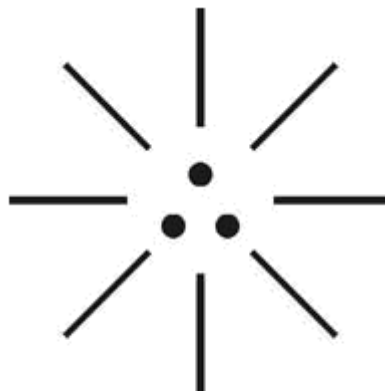

(Thai-ethu)

“The philosophy of word Thale, Thalib, Thalli might be derived from the root word Thai-e”

– Author

- g) **Case study on “Chhath”?...**

It is focused that the Devanagari word “**Chhatte**” meaning Ancient Hindu Gods **sun God, Surya, Chhathi Maiya** (Goddess Usha) might be derived from the philosophy of Proto-Indo origin root “**Jyothi**”.

- i) **Photon** is like **Sun God**
- ii) **Electron** is like **Surya God**
- iii) **Proton** is like **Usha God**
- iv) “**J**” is like “**Thai-e**”

h) Case study on “**Aboriginal Tribe**”?...

It is hypothesized that the philosophy of **Aboriginal Tribe**, “**Elem tribe**” in human Anthropological Science shall be considered derived from **Thai-e** (Dalit) populations. It is focused that **Thai-e** shall be considered as 1st origin of human population on the earth planet.

i) Case study on **marijuana plant**?...

It is hypothesized that the marijuana plant (**Endo**) shall be considered as the “**Plasma stage**”. Endo plant family “**Aceae**” descended from **MARS Planet**. Aceae shall be considered as “**genus**”. “**MARIJUNA**” shall also called as “**DALIT PLANT**” considered as having “**Stem cells**” of all the plants on the Earth planet.

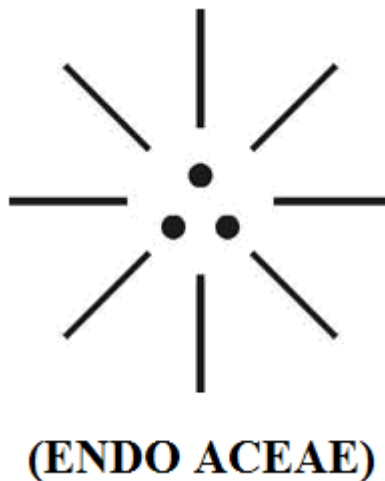

j) Case study on **DALIT Planet**?...

Case study shows that the whole Cosmo Universe consists of many galaxies and the living solar system having 9 planets say Mercury, Venus, Earth, Mars, Jupiter, Saturn, Uranus, Neptune being centered with Sun.

It is hypothesized that in the early universe **MARS, SUN, EARTH, MOON** shall be considered as the integral part of “**SYSTEM UNIVERSE**” called as “**WHITE STAR**” or “**MEGA STAR**” centered by “**MARS PLANET**”. The **MARS** planet shall also be called as **mother planet** of Universe. During the course of expanding Universe the formation of **comets, asteroids, meteoroids** shall be considered as genetically diffused **species** of **MARS** planet and also called as “**DALIT PLANETS**”. During three geological evolution three galaxies shall be considered as evolved due to change in relative position of **MARS, SUN, EARTH, MOON** which might have lead to formation of other planets which exists with different genetic characteristics in the respective galaxies as described below.

- (i) White Star System - Comprising of Genus planets **MARS, SUN, EARTH, MOON**
- (ii) Dalit Star (Black Star) - Comprising of **Comets, Asteroids, Meteoroids**
- (iii) Blue Star System - Comprising of **Blue MARS, Blue SUN, Blue EARTH, Blue MOON**
- (iv) Green Star System - Comprising of **Green MARS, Green Sun, Green Earth, Green Moon**
- (v) Red Star System - Comprising of **Red MARS, Red Sun, Red Earth, Red Moon**

k) Case study on **Thallus (Biology)**?...

Case study shows that **Thallus** is considered as undifferentiated vegetative body of **alage, fungi, lichins**. The plant has body without true stems, leaves, vascular system, characteristics of **Thallophytes**. It is focused that “**Thallus**” shall be considered as “**Dalit plant species**” on the earth planet.

l) Case study on **Thalassemia**?...

Case study shows that “**Thalassemia**” are forms of inherited autosomal recessive blood disorders that originated in the Mediterranean region. In thalassemia the disorder is caused by weakening and destruction of **red blood cells**. Thalassemia is caused by variant (or) **missing genes** that affect how the body makes Hemoglobin. Further alpha thalassemia, beta thalassemia, delta thalassemia shall be considered as having three ethnic disorders derived from three different lineages.

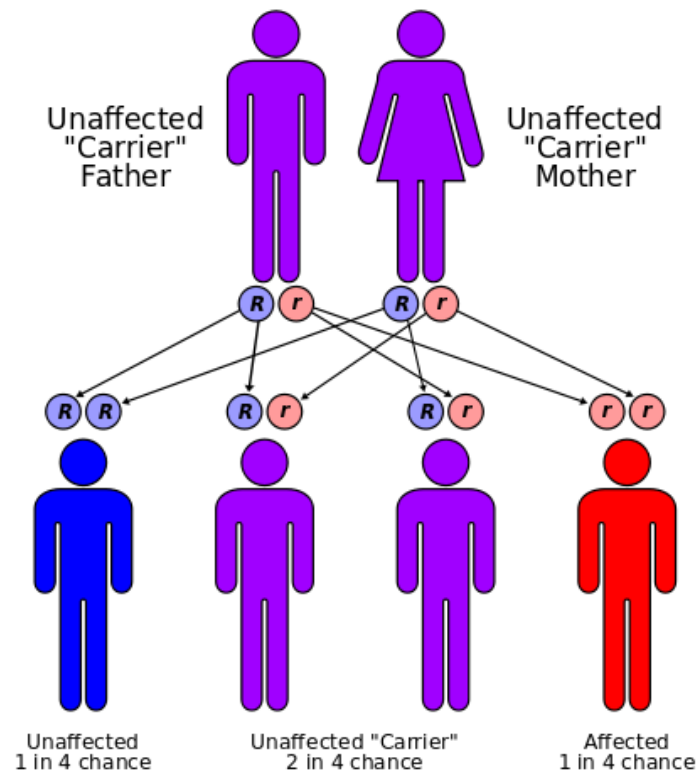

(Alpha, Beta, Delta Gene disorder Analysis)

It is hypothesized that Thalassemia shall be considered as genes transformed from “ENDO Origin” to INDO origin through “PLASMA STAGE”.

“Thalassemia disorder shall be considered as “DALIT SYNDROME” (Stem cells) due to lack of gene transfer to Ethiains”.

- Author

m) Philosophy of Dalit Blood Group?...

It is hypothesized that Ethian (Proto-Indo) shall be considered as the 1st Generation population on earth planet having only single type blood group “**AB**” (universal acceptor) derived from **DALIT POPULATION** (plasma human). The other blood type **A, B, O** shall be considered evolved in three lineage of population in three geological evolution i.e. A-type shall be derived from Indo-Dravidian origin, B-type from Indo-European origin, O-type from Indo-Egypt origin.

n) Philosophy of Dalit Eye Iris?...

It is hypothesized that the Eye Iris of Dalit population shall be considered as “**DARK BLACK IRIS**”. During the course of expanding Universe the different races having different Eye Iris shall be considered as evolved in different geological period due to varied environmental conditions as detailed below:

- (i) Dark blue iris -Indo Dravidian origin
- (ii) Dark Green iris -Indo European origin
- (iii) Dark Red iris- Indo Egyptian origin

III. CONCLUSION

It is focused that “**Dalit**” shall be considered as Plasma human just like “**Infant**” transformed from **Mother’s womb** through plasma region of **birth canal** to become “**Child**”. The Infant, child are considered as having distinguished genetically varied characteristics. “**Mazhalai**” shall be considered as **Intermediate stage** between infant and child also called as “**Dalit**” (Plasma human). Further the Philosophy of word “**TALLIT**” (Tzitzit) in Jewish / Hebrew custom might be derived from the Philosophy of **Dalit** (Thai-e).

(i)

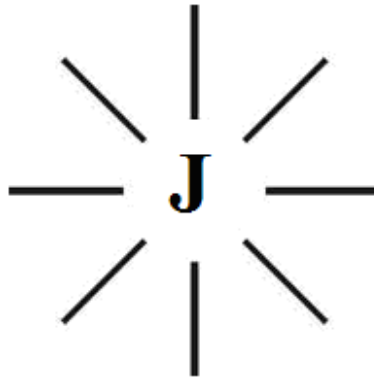

(CHISU)

(ii)

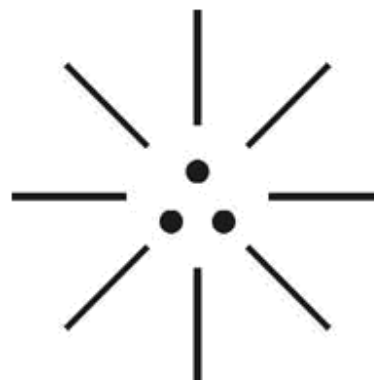

(TALLIT)

In proto-Indo language “**Mazhalai**” shall also be called as “**CHISU**”. CHISU shall mean diffusion stage of infant to become child called as “**MOTHER SUPREME**”.

IV. PREVIOUS PUBLICATION

The philosophy of origin of first life and human, the philosophy of model Cosmo Universe, the philosophy of fundamental neutrino particles have already been published in various international journals mentioned below. Hence this article shall be considered as **extended version** of the previous articles already published by the same author.

- [1] Cosmo Super Star – IJSRP, April issue, 2013
- [2] Super Scientist of Climate control – IJSER, May issue, 2013
- [3] AKKIE MARS CODE – IJSER, June issue, 2013
- [4] KARITHIRI (Dark flame) The Centromere of Cosmo Universe – IJIRD, May issue, 2013
- [5] MA-AYYAN of MARS – IJIRD, June issue, 2013
- [6] MARS TRIBE – IJSER, June issue, 2013
- [7] MARS MATHEMATICS – IJERD, June issue, 2013
- [8] MARS (EZHEM) The mother of All Planets – IJSER, June issue, 2013
- [9] The Mystery of Crop Circle – IJOART, May issue, 2013
- [10] Origin of First Language – IJIRD, June issue, 2013
- [11] MARS TRISOMY HUMAN – IJOART, June issue, 2013

- [12] MARS ANGEL – IJSTR, June issue, 2013
- [13] Three principles of Akkie Management (AJIBM, August issue, 2013)
- [14] Prehistoric Triphthong Alphabet (IJIRD, July issue, 2013)
- [15] Prehistoric Akkie Music (IJST, July issue, 2013)
- [16] Barack Obama is Tamil Based Indian? (IJSER, August issue, 2013)
- [17] Philosophy of MARS Radiation (IJSER, August 2013)
- [18] Etymology of word “J” (IJSER, September 2013)
- [19] NOAH is Dravidian? (IJOART, August 2013)
- [20] Philosophy of Dark Cell (Soul)? (IJSER, September 2013)
- [21] Darwin Sir is Wrong?! (IJSER, October issue, 2013)
- [22] Prehistoric Pyramids are RF Antenna?!... (IJSER, October issue, 2013)
- [23] HUMAN IS A ROAM FREE CELL PHONE?!... (IJIRD, September issue, 2013)
- [24] NEUTRINOS EXIST IN EARTH ATMOSPHERE?!... (IJERD, October issue, 2013)
- [25] EARLY UNIVERSE WAS HIGHLY FROZEN?!... (IJOART, October issue, 2013)
- [26] UNIVERSE IS LIKE SPACE SHIP?!... (AJER, October issue, 2013)
- [27] ANCIENT EGYPT IS DRAVIDA NAD?!... (IJSER, November issue, 2013)
- [28] ROSETTA STONE IS PREHISTORIC “THAMEE STONE” ?!... (IJSER, November issue, 2013)
- [29] The Supernatural “CNO” HUMAN?... (IJOART, December issue, 2013)
- [30] 3G HUMAN ANCESTOR?... (AJER, December issue, 2013)
- [31] 3G Evolution?... (IJIRD, December issue, 2013)
- [32] God Created Human?... (IJERD, December issue, 2013)
- [33] Prehistoric “J” – Element?... (IJSER, January issue, 2014)
- [34] 3G Mobile phone Induces Cancer?... (IJERD, December issue, 2013)
- [35] “J” Shall Mean “JOULE”?... (IRJES, December issue, 2013)
- [36] “J”- HOUSE IS A HEAVEN?... (IJIRD, January issue, 2014)
- [37] The Supersonic JET FLIGHT-2014?... (IJSER, January issue, 2014)
- [38] “J”-RADIATION IS MOTHER OF HYDROGEN?... (AJER, January issue, 2014)
- [39] PEACE BEGINS WITH “J”?... (IJERD, January issue, 2014)
- [40] THE VIRGIN LIGHT?... (IJCRAR, January issue 2014)
- [41] THE VEILED MOTHER?... (IJERD, January issue 2014)
- [42] GOD HAS NO LUNGS?... (IJERD, February issue 2014)
- [43] Matters are made of Light or Atom?!... (IJERD, February issue 2014)
- [44] THE NUCLEAR “MUKKULAM”?... (IJSER, February issue 2014)
- [45] WHITE REVOLUTION 2014-15?... (IJERD, February issue 2014)
- [46] STAR TWINKLES!?... (IJERD, March issue 2014)
- [47] “E-LANKA” THE TAMIL CONTINENT?... (IJERD, March issue 2014)
- [48] HELLO NAMESTE?... (IJSER, March issue 2014)
- [49] MOTHERHOOD MEANS DELIVERING CHILD?... (AJER, March issue 2014)
- [50] E-ACHI, IAS?... (AJER, March issue 2014)
- [51] THE ALTERNATIVE MEDICINE?... (AJER, April issue 2014)
- [52] GANJA IS ILLEGAL PLANT?... (IJERD, April issue 2014)
- [53] THE ENDOS?... (IJERD, April issue 2014)
- [54] THE “TRI-TRONIC” UNIVERSE?... (AJER, May issue 2014)
- [55] Varied Plasma Level have impact on “GENETIC VALUE”?... (AJER, May issue 2014)
- [56] JALLIKATTU IS DRAVIDIAN VETERAN SPORT?... (AJER, May issue 2014)
- [57] Human Equivalent of Cosmo?... (IJSER, May issue 2014)
- [58] THAI-e ETHIA!... (AJER, May issue 2014)

REFERENCE

- [1] Intensive Internet “e-book” study through, Google search and wikipedia
- [2] M.Arulmani, “3G Akkana Man”, Annai Publications, Cholapuram, 2011
- [3] M. Arulmani; V.R. Hemalatha, “Tamil the Law of Universe”, Annai Publications, Cholapuram, 2012
- [4] Harold Koontz, Heinz Weihriah, “Essentials of management”, Tata McGraw-Hill publications, 2005
- [5] M. Arulmani; V.R. Hemalatha, “First Music and First Music Alphabet”, Annai Publications, Cholapuram, 2012
- [6] King James Version, “Holy Bible”
- [7] S.A. Perumal, “Human Evolution History”
- [8] “English Dictionary”, Oxford Publications
- [9] Sho. Devaneyapavananar, “Tamil first mother language”, Chennai, 2009

- [10] Tamilannal, "Tholkoppiar", Chennai, 2007
- [11] "Tamil to English Dictionary", Suravin Publication, 2009
- [12] "Text Material for E5 to E6 upgradaton", BSNL Publication, 2012
- [13] A. Nakkiran, "Dravidian mother", Chennai, 2007
- [14] Dr. M. Karunanidhi, "Thirukkural Translation", 2010
- [15] "Manorama Tell me why periodicals", M.M. Publication Ltd., Kottayam, 2009
- [16] V.R. Hemalatha, "A Global level peace tourism to Veilankanni", Annai Publications, Cholapuram, 2007
- [17] Prof. Ganapathi Pillai, "Sri Lankan Tamil History", 2004
- [18] Dr. K.K. Pillai, "South Indian History", 2006
- [19] M. Varadharajan, "Language History", Chennai, 2009
- [20] Fr. Y.S. Yagoo, "Western Sun", 2008
- [21] Gopal Chettiar, "Adi Dravidian Origin History", 2004
- [22] M. Arulmani; V.R. Hemalatha, "Ezhem Nadu My Dream" - (2 Parts), Annai Publications, Cholapuram, 2010
- [23] M. Arulmani; V.R. Hemalatha, "The Super Scientist of Climate Control", Annai Publications, Cholapuram, 2013, pp 1-3